

photometrics[®]
evolve[™]

512 x 512 imaging array
16 x 16- μ m pixels

Primary applications:
Quantitative FRET
Multiprobe experiments
Ratiometric ion imaging
Confocal microscopy
Live-cell fluorescence imaging

Available with Exclusive
excelon[™]
 Technology

- ▶ Smallest, most powerful scientific EMCCD camera on the market
- ▶ Most advanced feature set available for low-light applications
- ▶ Lowest dark current available for an EMCCD camera
- ▶ Lowest read noise available for an EMCCD camera
- ▶ Ideal for sophisticated researcher and multi-user labs
- ▶ Superb electron multiplication (EM) gain and bias stability
- ▶ Most accurate EM calibration technique in the industry
- ▶ Available with exclusive eXcelon[™] technology
- ▶ Backed by Photometrics' worldwide support team

Features	Benefits
EM gain	Very high sensitivity Low-noise, impact-ionization process
Back-illuminated EMCCD	CCD97 or CCD97-X (with eXcelon technology), highest available quantum efficiency (>90% peak QE)
512 x 512 imaging array 16 x 16- μ m pixels	Optimized field of view and highest sensitivity
Intelligent FPGA design	Precise linearization of EM gain Self-calibrating linearization ensures truly quantitative data consistently, time and again Ensures bias stability to guarantee a stable background
PAR feedback system (Photometrics Active Regulation)	Delivers unsurpassed EM gain stability for outstanding signal fidelity across 16 bits
ACE technology (Advanced Clocking Enhancement)	Pixel-clock timing resolution 12x better than other EMCCD cameras Provides lowest noise floor and minimizes generation of spurious charge and background events
10-MHz readout	Excellent for high-speed image visualization
5- and 1-MHz readout	Perfect for high-precision photometry
Dual amplifiers	Select readout mode via software for optimized (1) high-speed / high-sensitivity performance (EM) or (2) wide-dynamic-range performance (traditional CCD mode)
16-bit digitization	Wide dynamic range allows detection of bright and dim signals in the same image
Frame-transfer EMCCD	100% duty cycle to collect continuous data No mechanical shutter required
C- mount	Easily attaches to microscopes, standard lenses, or optical equipment
Turbo-1394 [™] interface (IEEE-1394a)	Universally accepted interface that provides high-bandwidth, uninterrupted data transfer with no dropped frames Windows [®] XP/7
PVCam [®] Circular buffers Device sequencing	Supported by numerous third-party software packages Real-time focus Precise integration with shutters, filter wheels, etc.
Exclusive eXcelon Technology (optional)	Enhanced QE in Blue and near IR wavelengths Anti-Etaloning in near IR wavelengths

* Patent-pending Photometrics technology

Photometrics Advanced Features

Features	Benefits
Quant-View®	Allows camera to read out pixel values in terms of electrons measured, thereby enabling user to calculate actual photon flux
Electrons-per-gray-level selector	Allows user to select how many electrons will cause a single gray-level increase in the image data, thus permitting utilization of Quant-View while maintaining full dynamic range of EMCCD
Rapid-Cal®	3-minute EM calibration process is most accurate in industry; camera does not need to be detached from microscope; no special attachments required; user-initiated
Background Event Reduction Technology®	Identifies pixels that are likely to contain spurious event data and then makes corrections, if desired
Black-Lock® / Top-Lock®	Intensity-filtering tool narrows visualization to the intensity range of the image features in which the user is most interested
Vari-Bit® selectable bit depth (8-16 bits)	Improves image quality by matching digitization bit depth to actual intrascene dynamic range

The Photometrics Evolve 512 is the ultimate deep-cooled, back-thinned EMCCD camera. Years of engineering expertise have enabled Photometrics to perfect every element of the Evolve 512. The Evolve 512 offers life science researchers the world's first advanced feature set designed specifically for EMCCD cameras and for low-light-level bio-imaging applications. Each of the Evolve camera's revolutionary features can easily be enabled or disabled by the camera user via software control. This sophisticated functionality enhances the quantitative nature of the camera while simultaneously allowing researchers to concentrate on acquiring image data relevant to their work.

Specifications									
Read noise (e- rms @ Gain State 3)									
10 MHz EM Port	45e-								
5 MHz EM Port	32e-								
5 MHz non-EM Port	12e-								
1.25 MHz non-EM Port	6e-								
Pixel Well Depth									
Active area	200,000e-								
Gain register	800,000e-								
Bias stability									
A measurement of the camera stability when no light hits the sensor. A slope of zero would be ideal. See footnote #1.	±0.0006 ADU/Frame								
Gain stability									
A measurement of the stability of the electron multiplication applied to images. Ideal value would be 0. The stability of the EM gain applied can be quantified by measuring the slope of a sequence of images with known amount of light and EM Gain applied. See footnote #2.	±0.0012 ADU/Frame (@ 10MHz, 350X, Gain State 3, 20K ADU)								
Field uniformity									
The image quality of the EMCCD is assessed for gradients. A complete lack of any gradient (i.e a flat image) would provide a numerical value of 1.00 See footnote #3.	<table border="0"> <tr> <td>10 MHz EM</td> <td>1.04</td> </tr> <tr> <td>5 MHz EM</td> <td>1.10</td> </tr> <tr> <td>5 MHz STD</td> <td>1.06</td> </tr> <tr> <td>1 MHz STD</td> <td>1.02</td> </tr> </table>	10 MHz EM	1.04	5 MHz EM	1.10	5 MHz STD	1.06	1 MHz STD	1.02
10 MHz EM	1.04								
5 MHz EM	1.10								
5 MHz STD	1.06								
1 MHz STD	1.02								
Baseline bias value	500ADU but can be varied								
Cooling temperature	Air cooled (@ ambient air 20°C) - Standard -85°C Liquid cooled (@ ambient 20°C) - Optional -85°C								
Dark current	0.001 e-/pixel/sec (See footnote #4.)								
Background events									
(10 MHz, 1000X EM gain) Standard operation	0.0045 events/pixel (@ 1000X EM gain)								
(10 MHz, 1000X EM gain) BERT operation	not detectable (See footnote #5.)								
Relative charge transfer efficiency									
Photometrics is able to measure this on each camera and optimize this parameter.	Optimized on each camera (See footnote #6.)								
Charge transfer efficiency	As specified by CCD manufacturer's data sheet (See footnote #7.)								
Dark signal non-uniformity (DSNU)	As specified by CCD manufacturer's data sheet (See footnote #7.)								
Photoresponse non-uniformity (PRNU)	As specified by CCD manufacturer's data sheet (See footnote #7.)								
Parallel shift rate	0.7 μsec. This is optimized with Charge Transfer Efficiency (CTE) and CIC. Test results demonstrate that increasing parallel shift rate further can decrease CTE and increase CIC, adversely affecting image quality and sensitivity.								

Note: Specifications are subject to change.

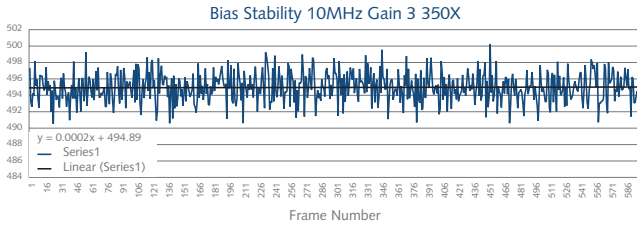

Note: Actual data.

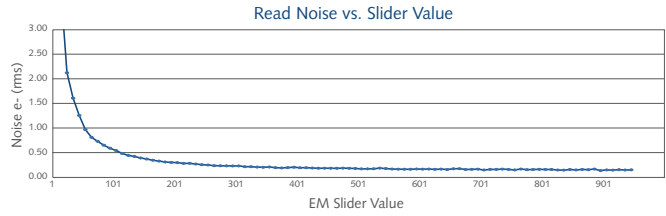

Note: Actual data, not theoretical.

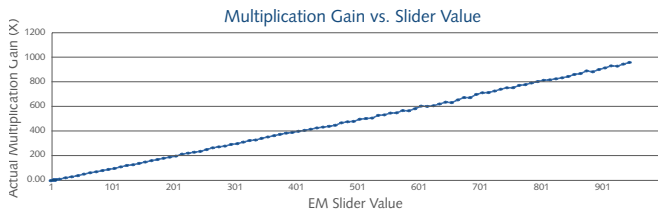

Note: Actual data from camera.

Binning	Region			
	512 x 512	256 x 256	128 x 128	64 x 64
1 x 1	33.7	65.5	124	224
2 x 2	65.8	124.4	224	376
4 x 4	124	224	376	563
8 x 8	224	374.5	562	748

(Frames per second)

Note: Frame rates are measured at 10 MHz with 0-second exposure times.

Exclusive eXcelon Technology (optional)

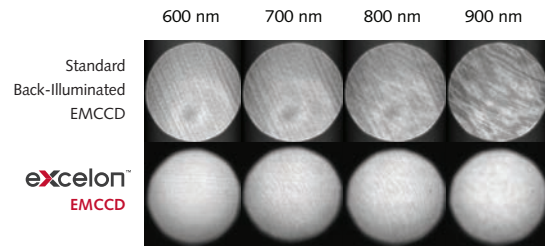
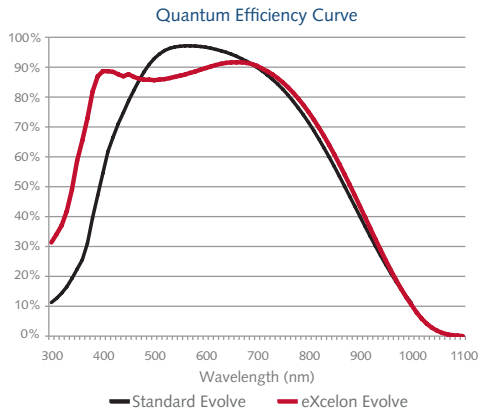

- Reduced Etaloning** Up to 10 times lower etaloning in near IR wavelengths compared to standard back-illuminated sensors
- Improved Sensitivity** Provides higher QE in the blue (<450nm) and near IR (>700nm)
- Exclusive Technology** Available on Evolve EMCCD Cameras

Liquid Cooled Evolve 512 EMCCD Camera (optional)

- Ideal for vibration-sensitive applications (eg. Atomic Force Microscopy)
- -85°C with ambient liquid*

*Note: Use of equipment not originally provided by Photometrics for use with Liquid Cooled Cameras will void any and all warranty coverage of the product. This is due to the specific requirements of the cooling system and camera based on the type of liquid, liquid viscosity, flow rate, among other key factors to achieve the specified performance levels.

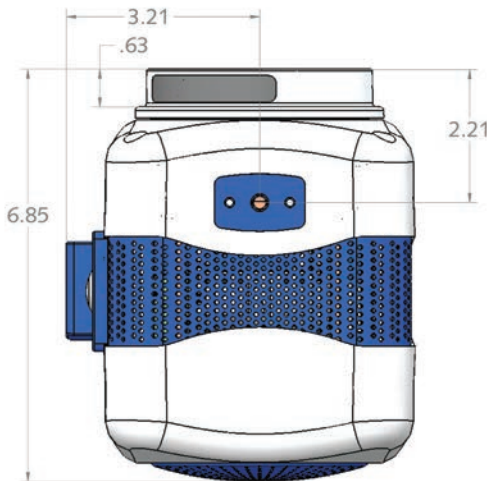
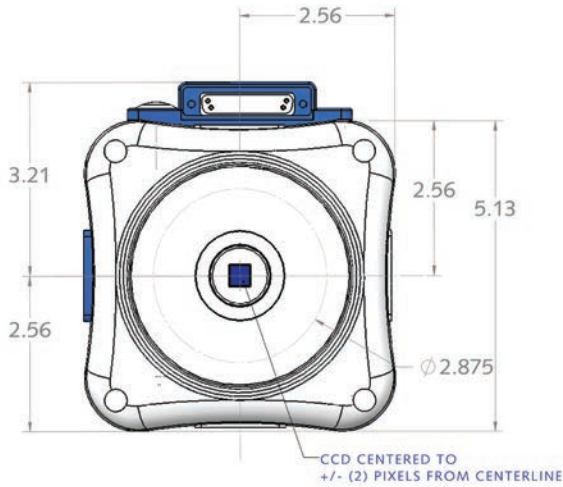

#1 Bias stability – The imaging stability of the EMCCD camera can be assessed by measuring its output with no light falling on the sensor and measuring the slope of the average intensity. The slope of the average intensity value of a 200 frame sequence (where $y=mx+b$ of the least squares fit) is measured.

#2 Gain stability – The actual amount of EM Gain applied on each image in a stream of images can vary depending on many electrical engineering factors. The slope of the average intensity value of a 200 frame sequence (where $y=mx+b$ of the least squares fit) (@ 10MHz, 350X, GS 3, 20K ADU) is measured. An ideal value would be zero.

#3 Field uniformity – Specification was obtained using the following formula: $-\sigma(\text{bias})/(\sigma(\text{bias}_1-\text{bias}_2)*.707) \leq 1.15$

#4 Dark current – This is measured in a traditional manner (as with all CCD cameras) by taking a long integration to obtain a signal. An average measurement is taken over the CCD area (excluding blemishes). It should be noted that dark current can vary significantly between different CCDs, and the numbers here are typical.

#5 Background events – As EMCCD cameras are actually capable of detecting single photons, the real detection limit of these cameras is set by the number of dark background events. These can arise from two things, dark current (which is thermal generation of an electron and is a temperature dependent phenomenon) and also clock induced charge (CIC) electrons (also called spurious charge). Each can lead to the generation of non-photon derived electrons which are multiplied through the electron-multiplication register, generating random high value pixels which are above the read noise.

These background events are measured by taking 30 ms exposure at 10MHz speed with 1000X EM Gain applied and counting the number of random high value pixels which are at a single event threshold above the modal value of the image histogram. This number is expressed as a probability of an event per pixel. The number can vary from frame to frame and sensor to sensor; however, a typical value is provided.

#6 Relative CTE – Photometrics employs an unpublished trade secret way of optimizing charge transfer efficiency. We have been doing this for years and are able to measure relative charge transfer efficiency and actually tune each camera in order to optimize this parameter. This ensures better optimal image performance.

#7 <http://www.e2v.com/products-and-services/high-performance-imaging-solutions/technical-papers/>

Photometrics, Evolve, and PVCam are registered trademarks of Photometrics. Background Event Reduction Technology, Black-Lock / Top-Lock, Quant-View, Rapid-Cal and Vari-Bit are trademarks of Photometrics. Other brand and product names are the trademarks or registered trademarks of their respective owners and manufacturers.